



Welcome!

Webinar #20: Cooling System Optimization

24 Jan 2018

Agenda:

- * Introduction
 - Cooling Systems in Thermoflow software
 - CS at the design point
 - Cooling System design optimization
 - CS at off design
 - Cooling System off design optimization
 - Examples
- * Q & A Session

Thermoflow Training and Support

- Standard Training
- On site training course
- Advanced Workshop
- Webinars when new version is released
- Help, Tutorials, PPT, Videos
- Technical Support

→ Feature Awareness Webinars

Feature Awareness Webinars

- 1- Assemblies in TFX
- 2- Scripts in Thermodflow programs, GTP-GTM-TFX
- 3- Multi Point Design in GTP-GTM
- 4- Reciprocating Engines in TFX
- 5- TIME in GTM
- 6- Matching ST Performance in STP
- 7- Modeling Solar Systems in TFX
- 8- Combining THERMOFLEX & Application-Specific Programs
- 9- Methods & Methodology in GT PRO & STEAM PRO
- 10- Supplementary Firing & Control Loops in GT PRO & GT MASTER
- 11- The Wind Turbine Feature in Thermodflex
- 12- Modelling GT's in Thermodflow programas-1
- 13- Thermodflex for on line and off line performance monitoring
- 14- Tflow 27, what's new
- 15- Modelling GT's in Thermodflow programas-2
- 16- Multi Point Design in GTP-GTM
- 17- Total Plant Cost in TFX
- 18- Steam Turbine Tuning
- 19- User Defined Components in TFX



20- Cooling System Optimization

Cooling System @ the design point

- Cooling Systems types in Thermoflow programs
- Main Inputs
- Automatic Design: Default Values (low cost- high efficiency) – GTP-STP
- Main Outputs
- Comparison of different systems performance & cost, automatic design → *Example 1a*
- Techno-Economic Optimization (ROI, NPV), via *Multiple Runs* or *Elink* - GTP-STP → *Example 1b*

Cooling System types: Water Cooled

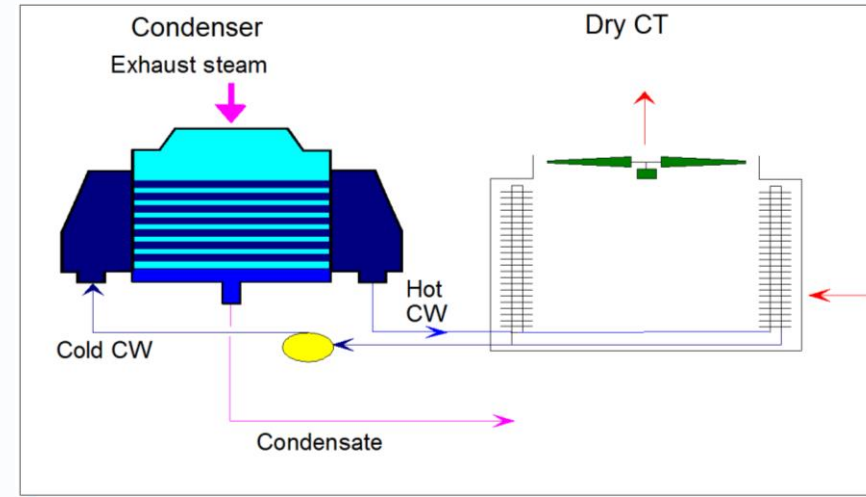
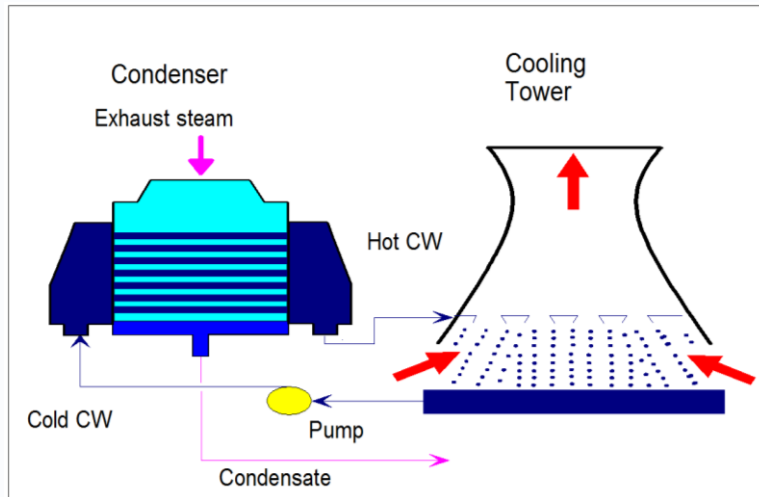
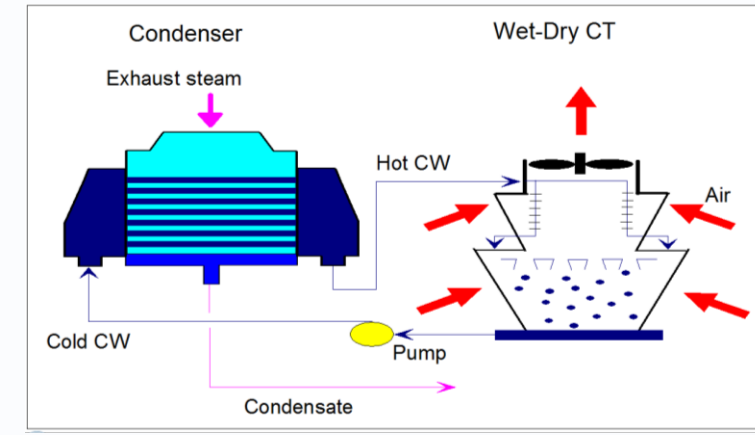
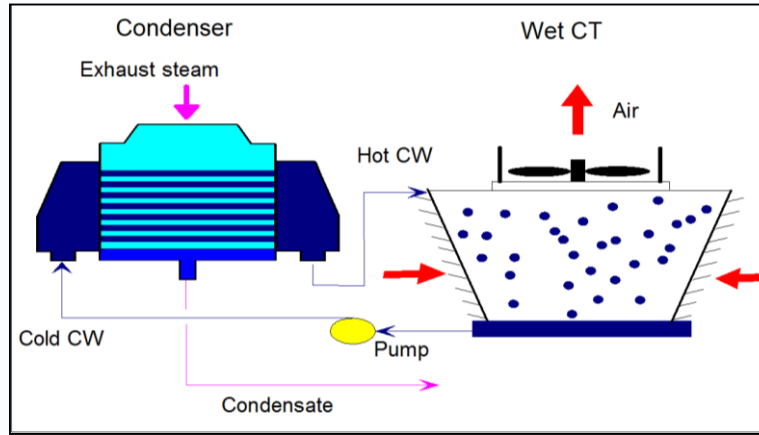
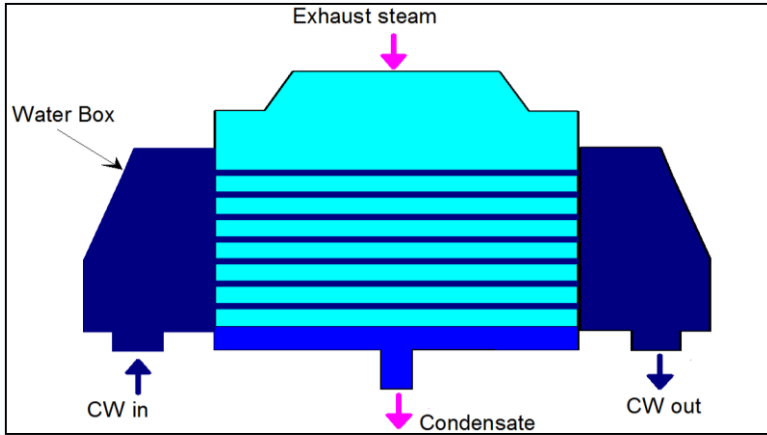

Cooling System types: Air Cooled

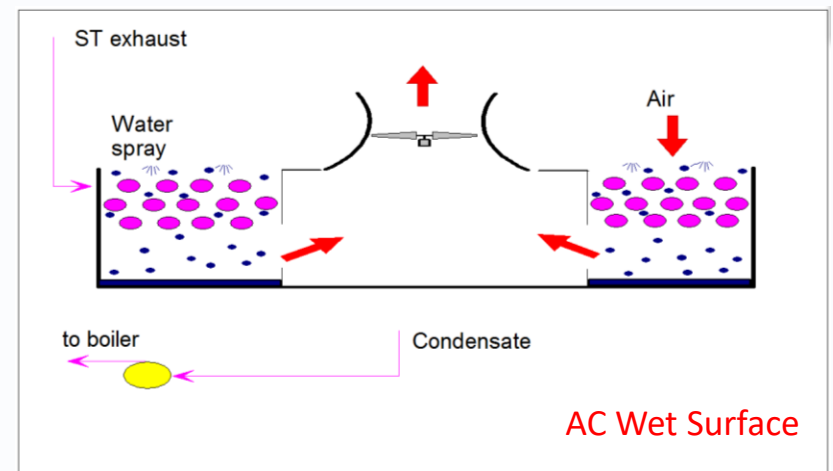
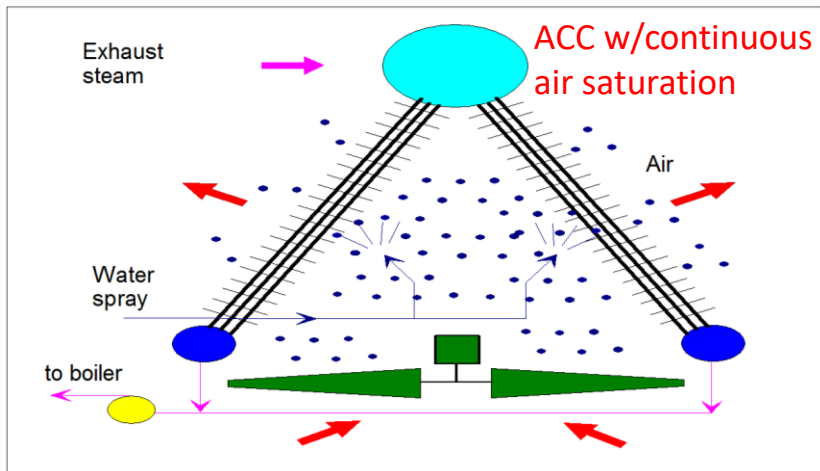
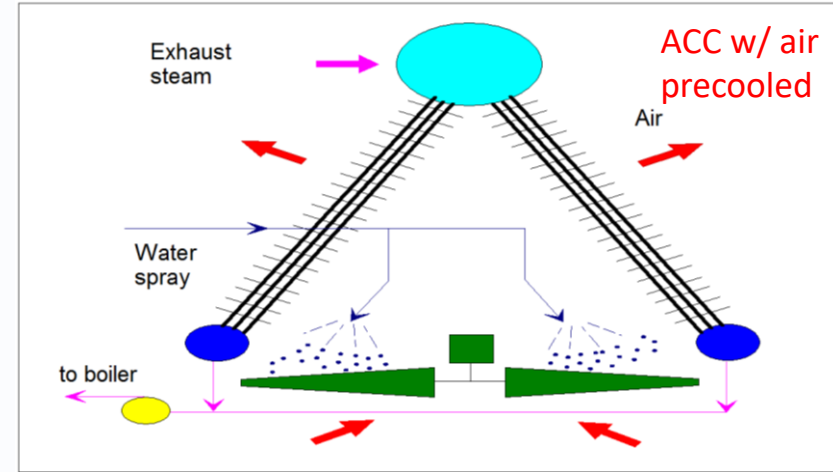
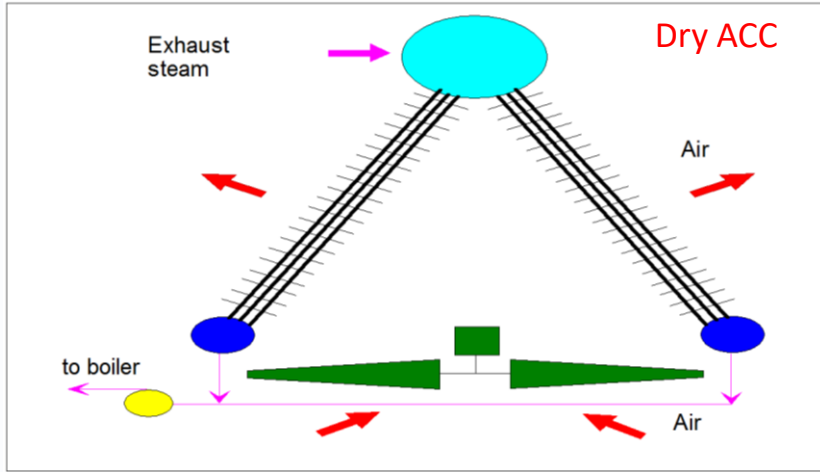

Cooling System types: Others

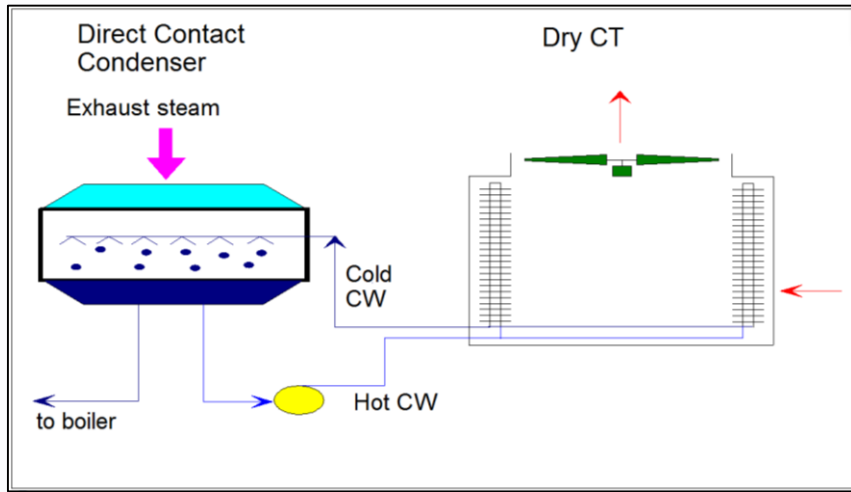

Heller System (GTP)

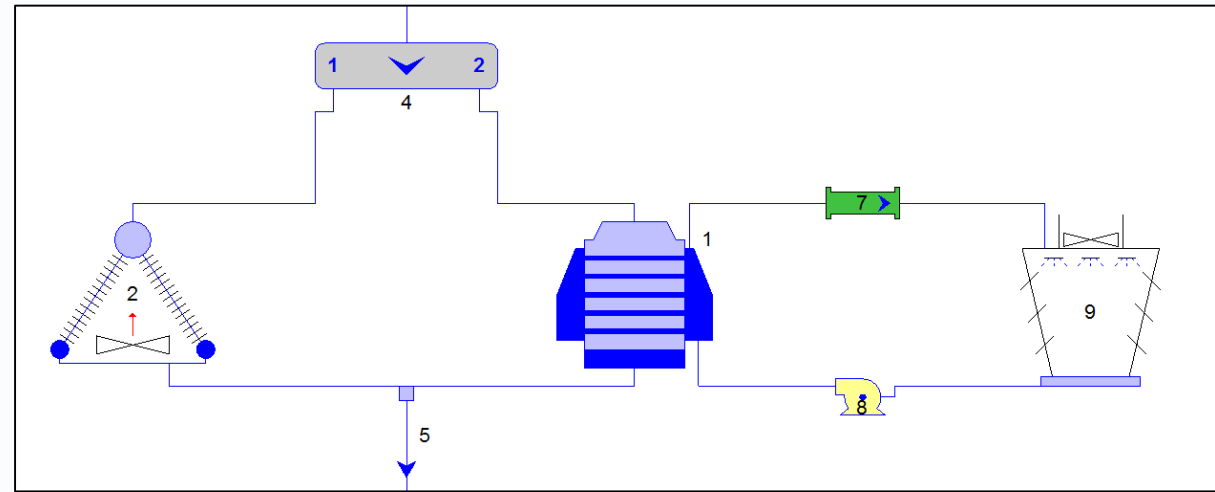

Hybrid Systems in TFX

Cooling System @ Design: Main Inputs

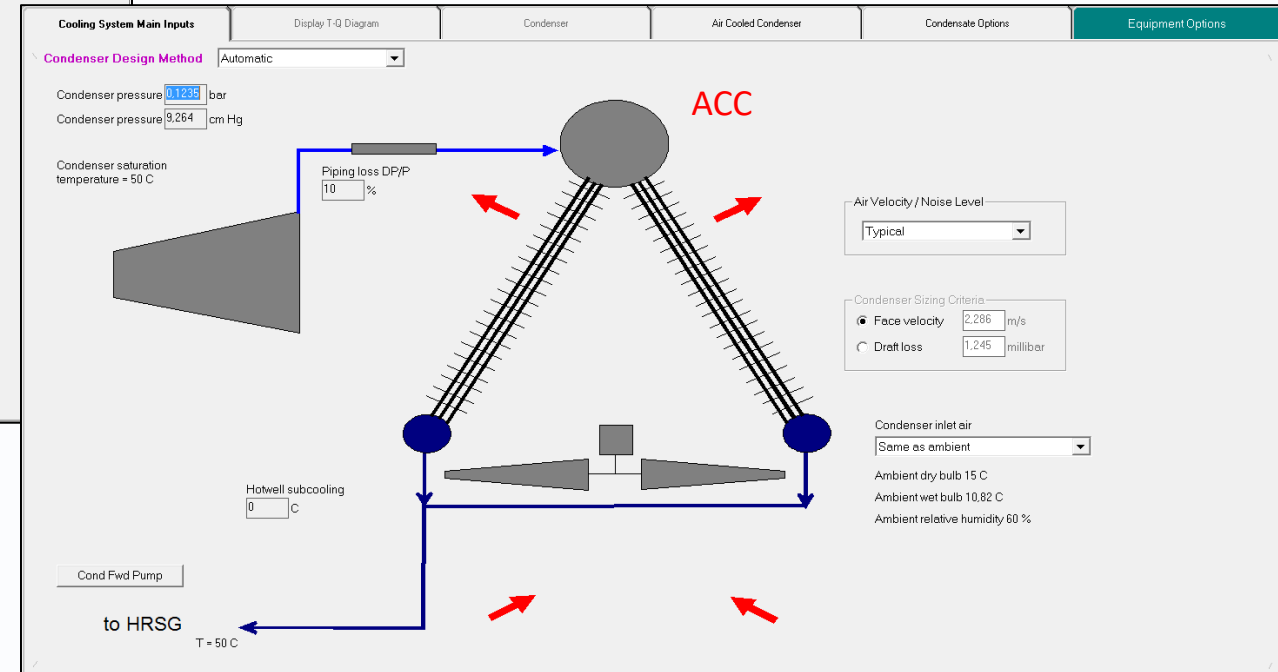
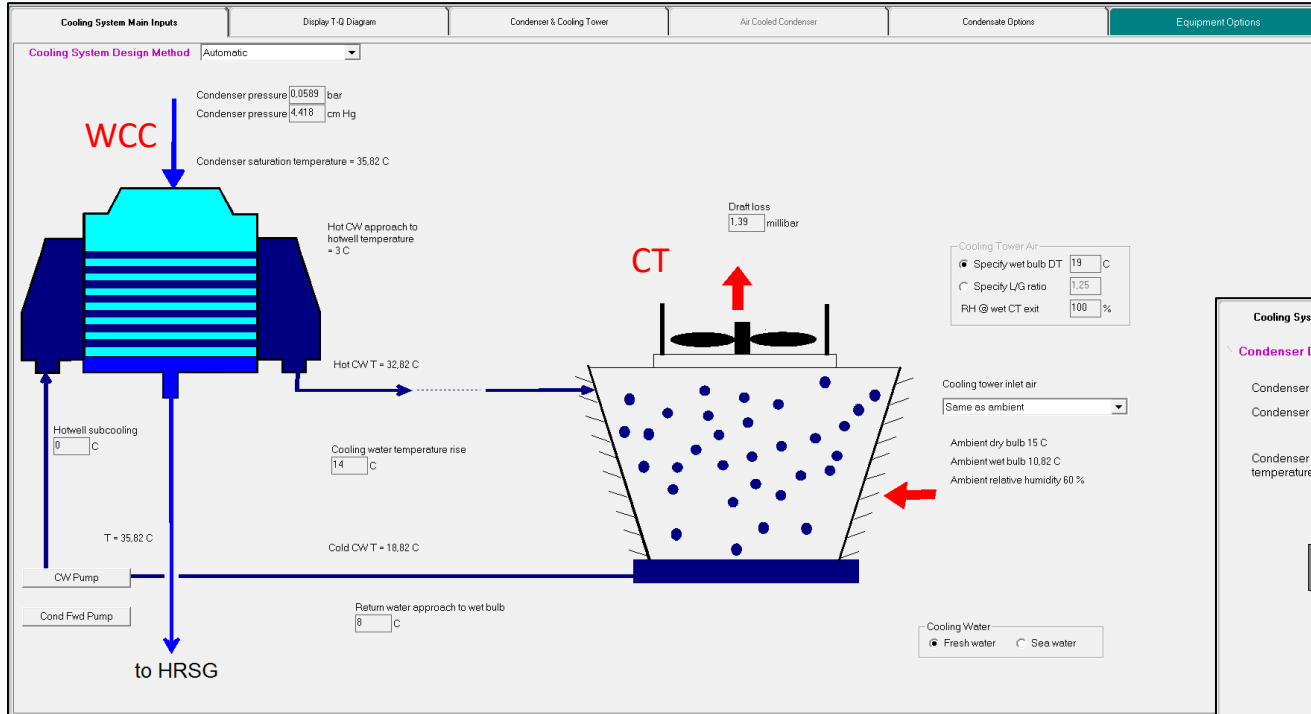

Default Values for Automatic Design (cost – eff)

Cooling System @ Design: Main Outputs

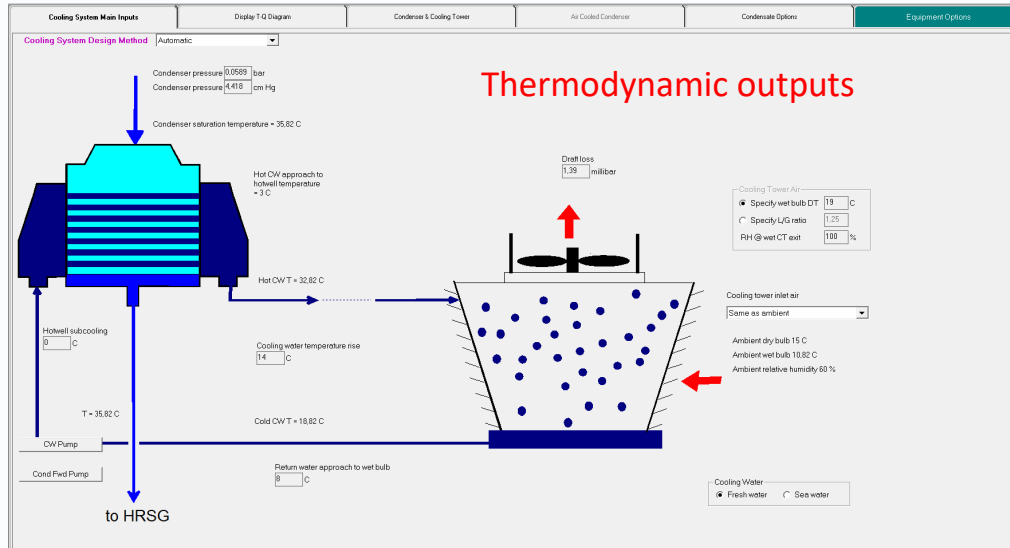

Preliminary Engineering | Financial | Heat Balance

Schematics | **Equipment Data** | Cost Report | Cash Flow | Graphics

Plant | Gas Turbine | HRSG | Steam Turbine | **Cooling System** | Gasification | Desalination | Miscellaneous

Condenser | Cooling Tower

PEACE: Hardware / Cost

Estimated Condenser Data		
Number of Units		1
Condenser Type		Shell & Tube
Condenser Cost (per unit), Reference Basis		1,863,000 USD
1. Condenser Tube Description (per unit)		
Effective Surface Area		7,030 m ²
Number of Condenser Passes		2
Tube Material		Stainless Steel (304)
Number of Tubes		5981
Tube Length		11.8 m
Tube Outside Diameter (O.D.)		31.75 mm
Tube Inside Diameter (I.D.)		30.33 mm
Tube Wall Thickness		0.7112 mm
Tube Weight, dry		39,220 kg
Tube Pitch		50.8 mm
2. Condenser Shell Description (per unit)		
Shell Material		Carbon Steel
Nominal Shell Thickness		15.88 mm
Number Tube Support Plates		14
Tube Support Plate Spacing		0.78 m

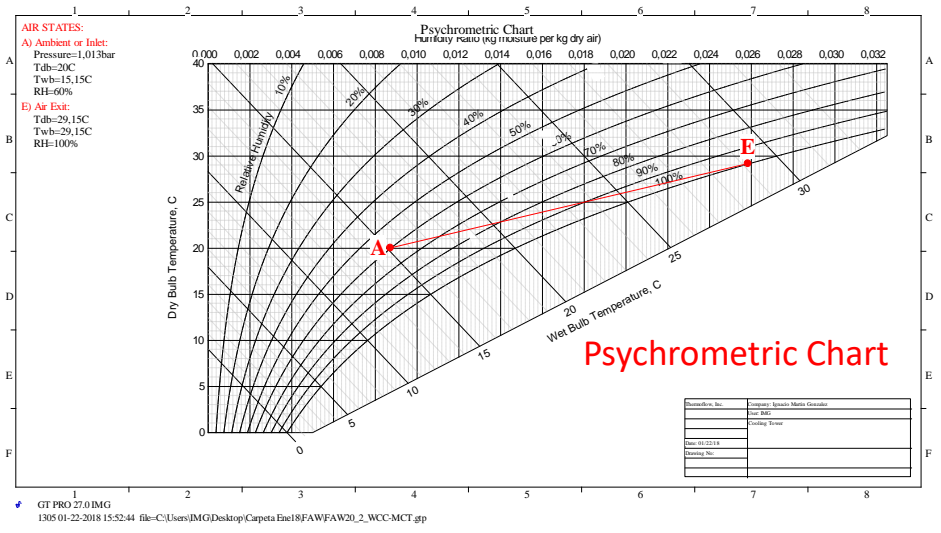
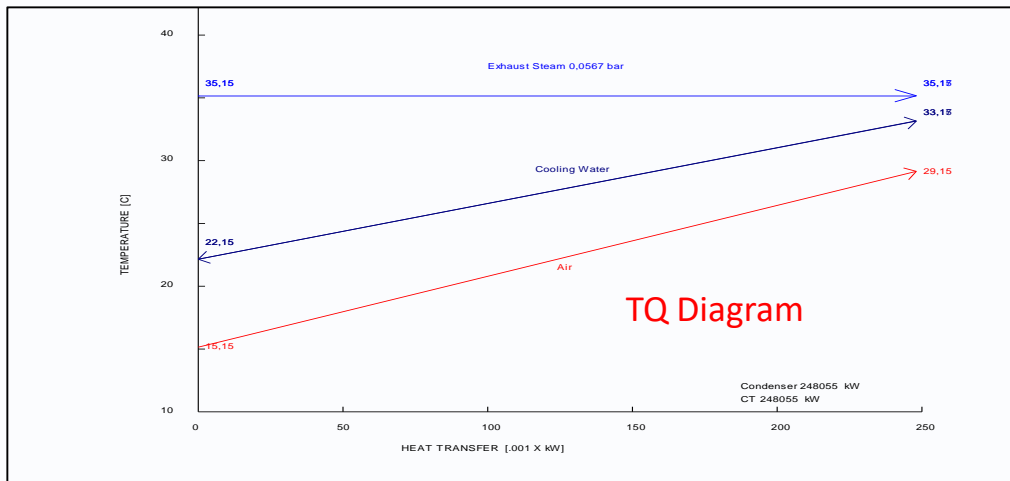

Cooling System different types comparison (automatic design)

Example 1a: GT Pro, Automatic Design, GT SGT5-4000F, 20 C, 3PRH, High Efficiency

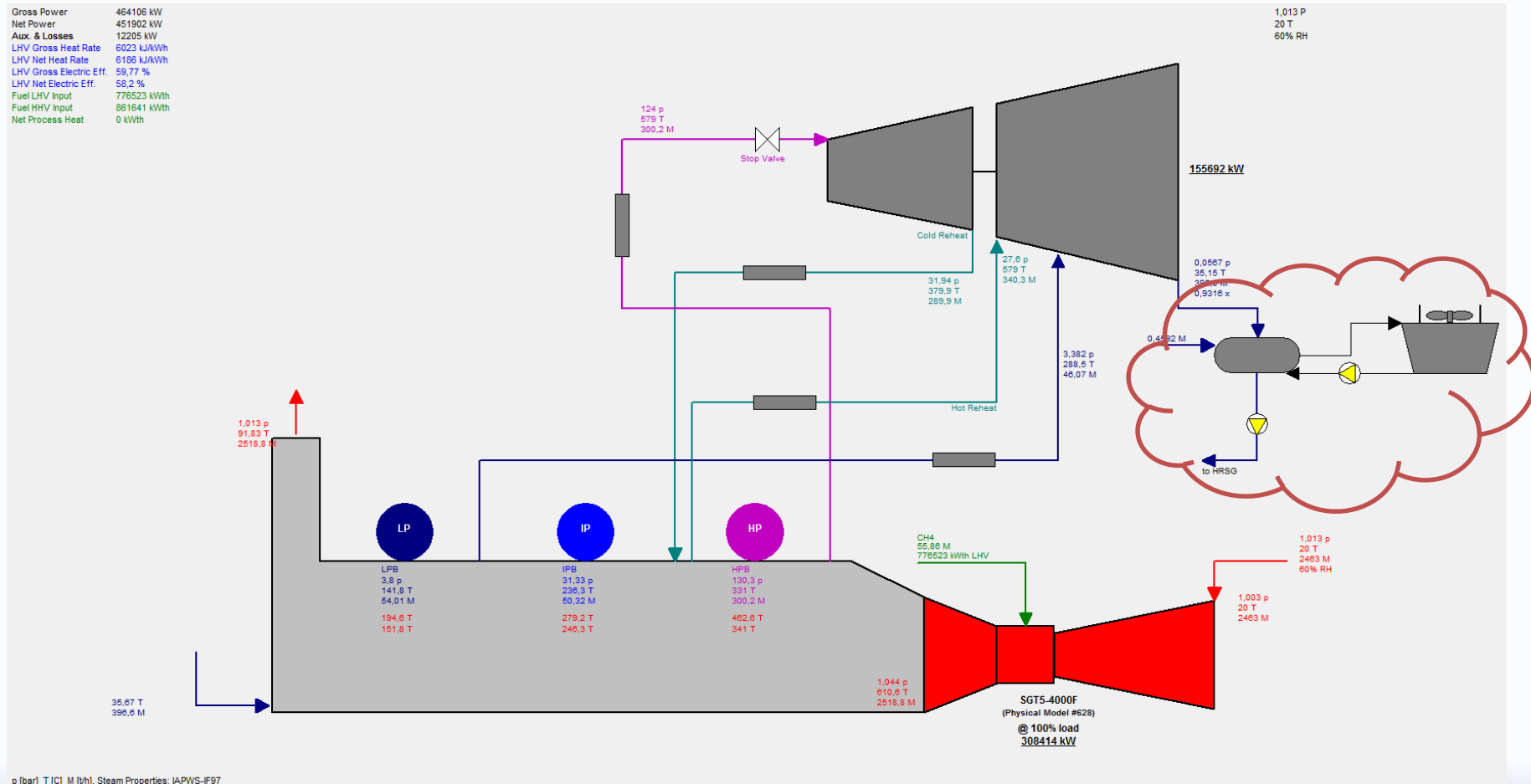

Cooling System different types comparison (automatic design)

- Condenser Pressure
- DTs: Saturation-Cooling Water-DBT-WBT
- Gross, Net Power
- Net Efficiency
- Auxiliary Power associated to the CS
- Size: Condenser Surface Area, CT Number of Cells, Plot
- Cost: CS Cost (Condenser, CT, CWPump, CW Pipe, ...) / Total Plant Cost
- Financial: ROI, NPV, LCOE

Cooling System different types comparison (automatic design)

Example 1a: GT Pro, Automatic Design, GT SGT5-4000F, 20 C, 3PRH, High Efficiency

	Units	WCC OT	WCC MCT	WCC w-d CT	WCC NDCT	WCC dCT	ACC	ACC w/air prec	ACC w/air sat	ACC wet surface	Heller
Amb T	°C	20	20	20	20	20	20	20	20	20	20
RH	%	60	60	60	60	60	60	60	60	60	60
WBT	°C	15,1	15,1	15,1	15,1	15,1	15,1	15,1	15,1	15,1	15,1
Site CW	°C	15	N/A	N/A	N/A	N/A	N/A	N/A	N/A	N/A	N/A
Cond P	mbara	48,3	56,7	83,8	56,7	83,1	123,5	96,7	96,7	96,7	83,1
Sat T	°C	32,2	35,1	42,4	35,1	42,2	50,0	45,1	45,1	45,1	42,2
DT-WBT	°C	17,1	20,0	27,3	20,0	27,1	34,9	30,0	30,0	30,0	27,1
DT-Amb	°C	12,2	15,1	22,4	15,1	22,2	30,0	25,1	25,1	25,1	22,2
Total CS Aux	MW	1,2	2,9	2,2	1,7	5,3	1,7	1,7	1,2	0,6	4,6
Cond surface	m2	7.029	13.850	9.123	13.850	14.517	537.320	540.785	376.521	32.026	
ACC plot	m2						2657	2676	1863	2654	
Water consumption	t/h	0	372	335	372	0	0	79	394	384	0
Net Power	MW	455,4	451,9	448,0	453,1	444,5	441,8	445,0	445,5	446,1	445,2
Net Eff	%	58,65	58,20	57,69	58,35	57,24	56,89	57,30	57,36	57,45	57,33
Total CS Cost	MUSD	6,4	8,9	9,1	57,5	26,1	17,0	17,7	13,0	6,5	23,0
Total Plant Cost	MUSD	321,1	326,4	320,5	369,8	354,6	334,5	339,8	328,6	321,6	347,8
Specific Cost	USD/kW	705,2	722,3	715,5	816,2	797,7	757,1	763,6	737,7	720,9	781,3
ROI ***	%	20,29	19,54	19,50	17,61	17,67	18,36	18,36	18,82	19,24	18,04

Cooling System Design Techno-Economic Optimization (GTP-STP)

Example 1b: GT Pro, Automatic Design, GT SGT5-4000F, 20 C, 3PRH, High Efficiency, ACC

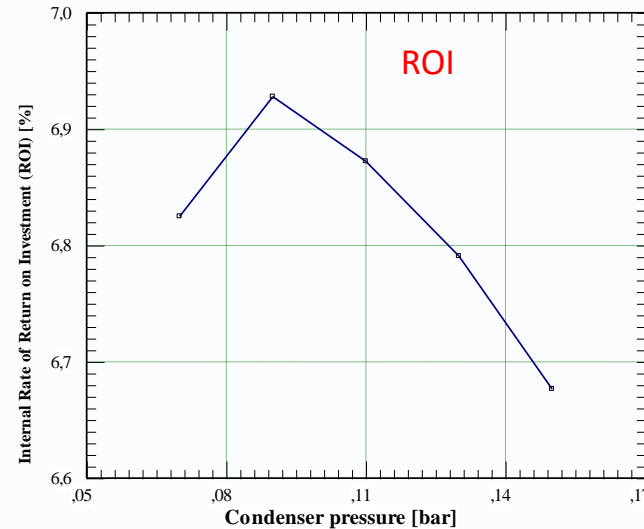
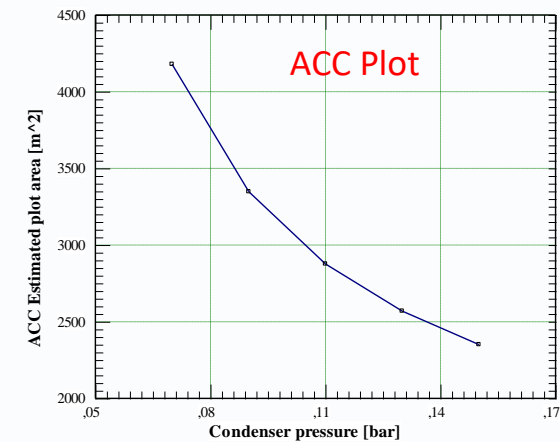
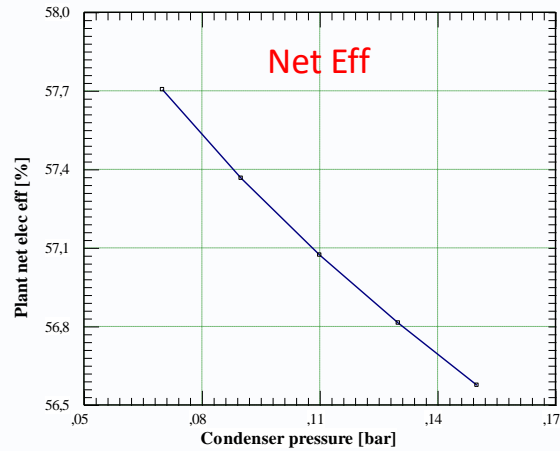

- ➔ Make the Cond P user defined in GTP/STP
- ➔ Use Multiple Runs or Elink to find the optimum ROI / NPV
- ➔ Effect of the Economic Assumptions
- ➔ Select the simple *Nameplate Mode* or more detailed *Annual Model* or *TIME*

Cooling System @ off design

Off Design (GTM-STM-TFX OD)

- Main inputs, limits and controls
- Automatic Optimization to maximize Net power (GTM-STM)
- Use Searcher for Optimization (TFX)
- Use ELink for comparison
- Examples

Cooling System @ off design, Main Inputs

WCC

- Minimum / Maximum Condenser Pressure
 - Prevent Choke option
 - CW Flow: User Defined / computed from Pump – number of CW Pumps running
- } Limited by CW Flow / n. of operating CT cells

WCT

- Number of Cells full speed / half speed, existing / operating
- CT shutdown
- Minimum Basin Temperature
- Air RH at exit
- CT water distribution: All Cells / Operating Cells

ACC

- Minimum / Maximum Condenser Pressure
 - Prevent Choke option
 - Number of Cells full speed / half speed, existing / operating
 - Spray Water option / exit Air RH
- } Limited by Air Flow / n. of operating ACC cells

Cooling System @ off design, Inputs WCC+MCT

Cooling System Main Inputs

Cooling System Optimisation:

Minimum condenser pressure: bar

Maximum condenser pressure: bar

Prevent condenser pressure below choke limit

Condenser Hardware

Cooling Water Flow: User-defined Computed from pump capacity and flow resistance

Condenser Pressure Limited by: Coolant flow No. of operating CT cells

CT Cooling Water Distribution: All cells Operating cells

Cooling Tower Hardware

Fan power CF =

Cooling tower is shut down

Condensate Options

Number of existing cells per ST

1-speed 2-speed

Number of operating cells per CT

Full speed Half Zero

Sizing air flow per cell = m³/s

Full speed cell air flow/sizing %

Half speed cell air flow/sizing %

Zero speed cell air flow/sizing %

Cooling tower inlet air:

Ambient dry bulb 15 C
Ambient wet bulb 10,82 C
Ambient RH 60 %

Tube water velocity = 1,826 m/s
Number of tubes = 3392
Surface area = 1222,2 m²

CW flow per cell = 456,6 t/h

Sizing flow = 1826,4 t/h
Cooling water flow per condenser t/h

Hotwell subcooling C

to HRSG

CT minimum basin temperature C

[Click here to edit cooling water pipe details on the 'Pipes' tab of the 'Pipes, Pumps, etc.' PEACE ONLY topic.](#)

Cooling Water: Fresh water Sea water

Condenser model: GT MASTER model without adjustment curves. Cooling tower model: GT MASTER model without adjustment curves.

Cooling System @ off design, Inputs ACC

Cooling System Main Inputs

Cooling System Optimisation:

Minimum condenser pressure: bar

Maximum condenser pressure: bar

Prevent condenser pressure below choke limit

Spray water on condenser

Condenser Performance Method:

Cond Fwd Pump Details:

to HRSG

Condenser Hardware

Condenser Pressure Limited by:

Air flow No. of operating ACC cells

Pipe resistance coefficient: m⁻⁴

Hotwell subcooling: C

Condensate Options

Number of existing cells per ST

1-speed: 2-speed:

Number of operating cells per CT

Full speed: Half: Zero:

Fan power correction factor:

Sizing flow per cell = 241,7 m³/s

Full speed cell air flow/sizing: %

Half speed cell air flow/sizing: %

Ambient dry bulb 15 C

Ambient wet bulb 10,82 C

Ambient relative humidity 60 %

Condenser inlet air:

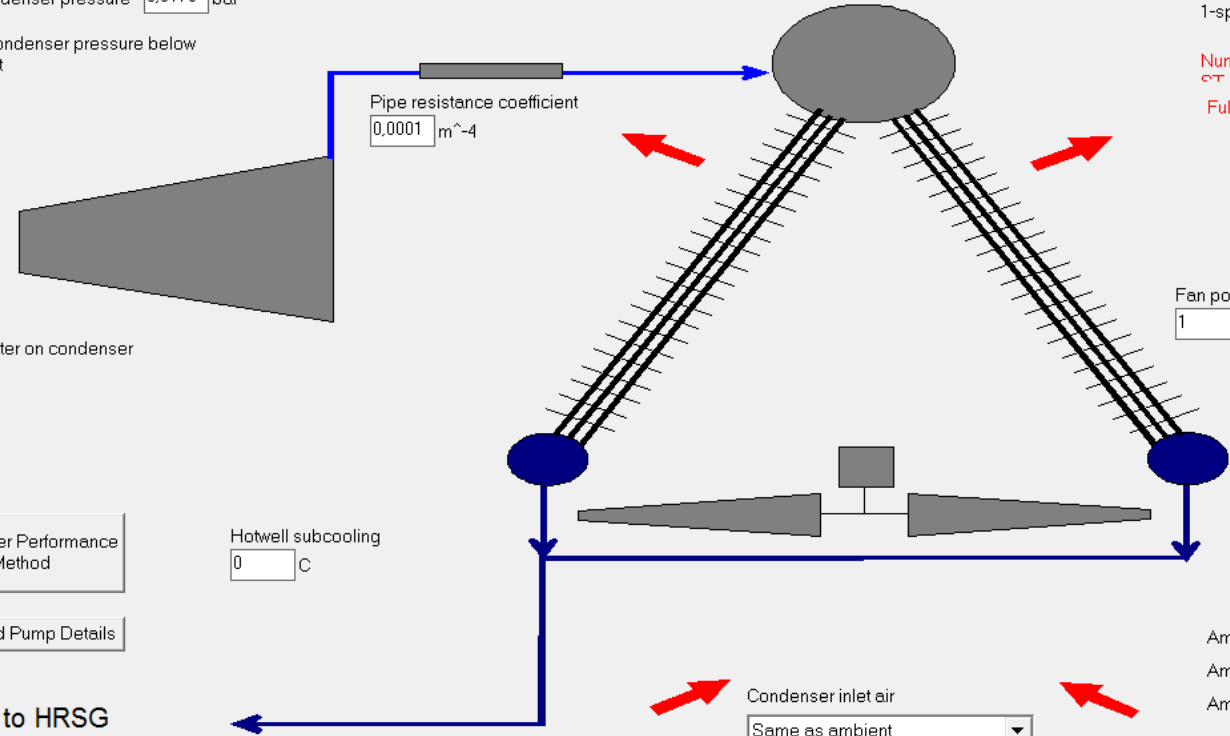

Condenser model: GT MASTER model without adjustment curves.

Cooling System @ off design Optimization

- Automatic Optimization to maximize Net Power (WCC-CT-ACC) / (GTM-STM) → *Example 2*
- Spray Water to ACC to increase output at peak conditions (GTM-TFX) → *Example 3*
- CT n. of cells optimization to maximize Net Power using Searcher (TFX) → *Example 4*
- Hybrid Condenser in TFX, link to GTP/GTM → *Example 5*

Automatic Optimization to maximize Net Power

Example 2: GT Master, GT SGT5-4000F, 3PRH, WCC+WCT, 2 CWP-7 CT Cells. Optim. @ 2 °C

The screenshot displays the 'Cooling System Main Inputs' section of the GT MASTER software. The 'Cooling System Optimisation' dropdown is set to 'On - Max. plant net power'. The 'Cooling Water Flow' is set to 'Computed from pump capacity and flow resistance'. The 'Condenser Pressure Limited by' is set to 'No. of operating CT cells'. The 'CT Cooling Water Distribution' is set to 'All cells'. The 'Number of existing cells per ST' is 7 for 1-speed and 0 for 2-speed. The 'Number of operating cells per CT' is 7 for Full speed, 0 for Half, and 0 for Zero. The 'Sizing flow' is 19420 t/h. The 'Cooling water flow per condenser' is 19420 t/h. The 'CW flow per cell' is 2774.3 t/h. The 'Sizing air flow per cell' is 614.1 m³/s. The 'Full speed cell air flow/sizing' is 100%, 'Half speed cell air flow/sizing' is 62.5%, and 'Zero speed cell air flow/sizing' is 10%. The 'Cooling tower inlet air' is set to 'Same as ambient'. The 'Ambient dry bulb' is 20 C, 'Ambient wet bulb' is 15.15 C, and 'Ambient RH' is 60%. The 'CT minimum basin temperature' is 7.222 C. The 'Cooling Water' is set to 'Fresh water'. The 'Hotwell subcooling' is 0 C. The 'Tube water velocity' is 2.07 m/s, 'Number of tubes' is 11561, and 'Surface area' is 13851 m². The 'Fan power CF' is 1. The 'Cooling tower is shut down' checkbox is unchecked. A link is provided to edit cooling water pipe details on the 'Pipes' tab of the 'Pipes, Pumps, etc.' PEACE ONLY topic.

Condenser model: GT MASTER model without adjustment curves. Cooling tower model: GT MASTER model without adjustment curves.

Automatic Optimization to maximize Net Power

Optimization OFF

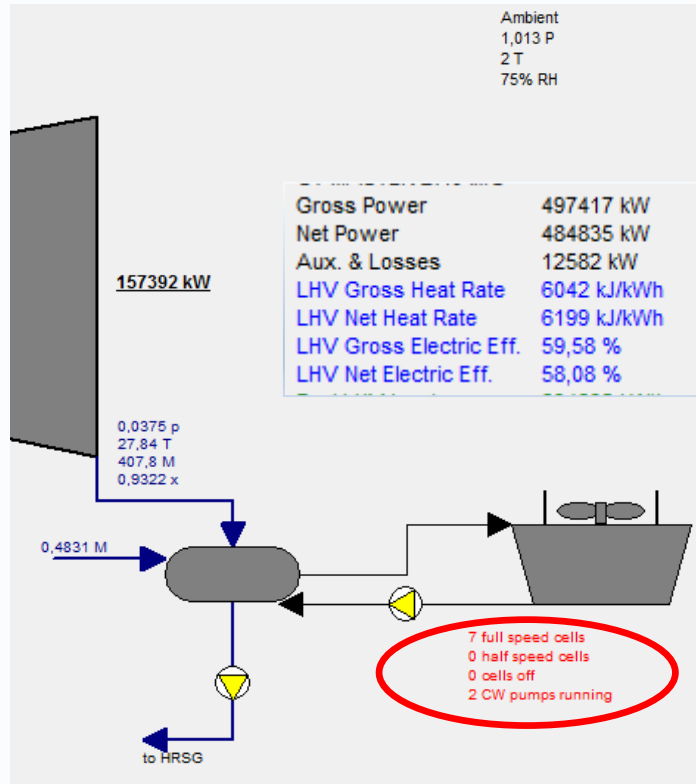

Optimization ON

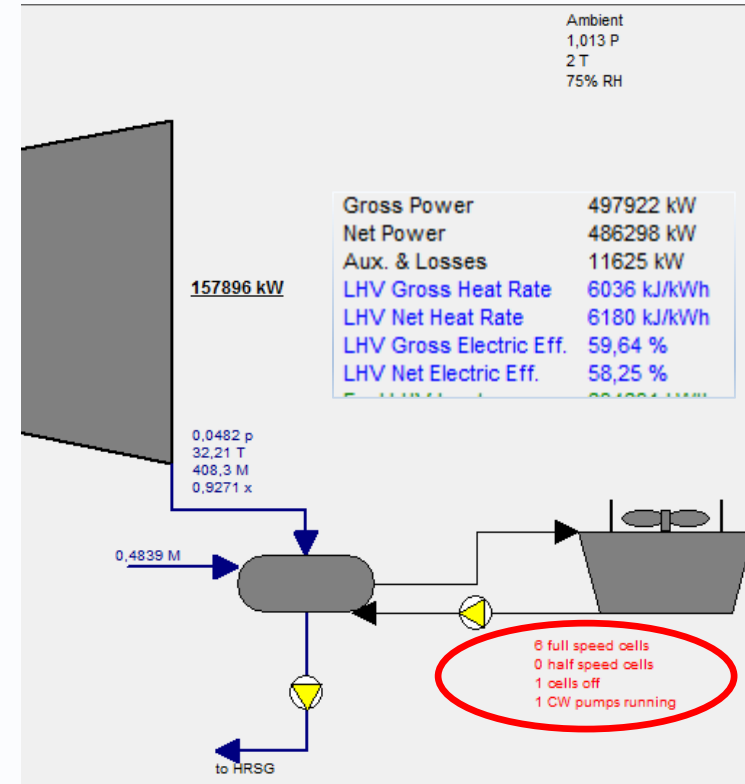

Automatic Optimization to maximize Net Power

Effect of Exhaust End design and Exhaust Loss calculation on optimization !!!

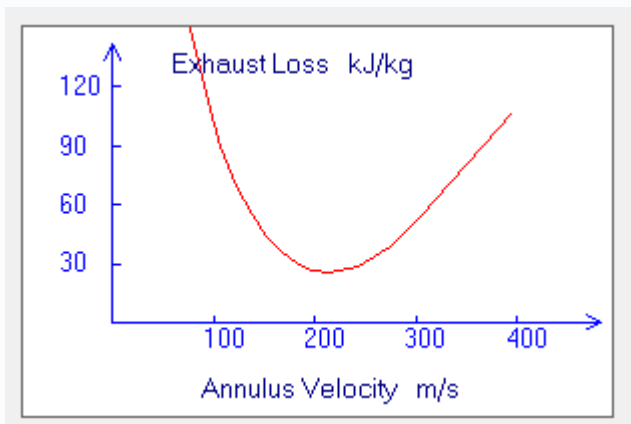
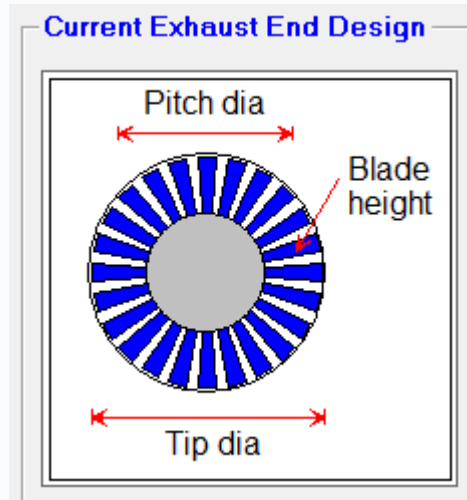

<i>Optimization</i>		Cond P	Net P
N. CT Cells	N. CW Pumps	mbara	MW
6	1	49,0	486,3
7	1	41,6	488,9
7	2	36,8	492,4

EL = Auto

EL = 1/2 Auto

No EL

Spray Water to ACC to increase output at peak conditions

Example 3: GT Master, GT SGT5-4000F, 3PRH, ACC. Spray to 100% RH @ 35 C

Main Inputs | Plant Criteria | GT Inputs | ST Inputs | ST Process | HRSG Inputs | HRSG Process | Water Circuits | **Cooling System** | Environment | Gasification | Desalination | Site | Major Equipment | Pipes, Pumps | Economics | Re-design in GT PRO | COMPUTE

Cooling System Main Inputs

Cooling System Optimisation:

Condenser Pressure Limited by: Air flow No. of operating ACC cells

Minimum condenser pressure: bar
 Maximum condenser pressure: bar

Prevent condenser pressure below choke limit

Pipe resistance coefficient: m⁻⁴

Number of existing cells per ST:
 1-speed: 2-speed:

Number of operating cells per cell:
 Full speed: Half: Zero:

Spray water on condenser

Exit relative humidity: %

Fan power correction factor:

Water spray

Sizing flow per cell = 622.6 m³/s
 Full speed cell air flow/sizing: %
 Half speed cell air flow/sizing: %

Hotwell subcooling: C

Ambient dry bulb 20 C
 Ambient wet bulb 15,15 C
 Ambient relative humidity 60 %

Condenser inlet air:

to HRSG

Condenser model: GT MASTER model without adjustment curves.

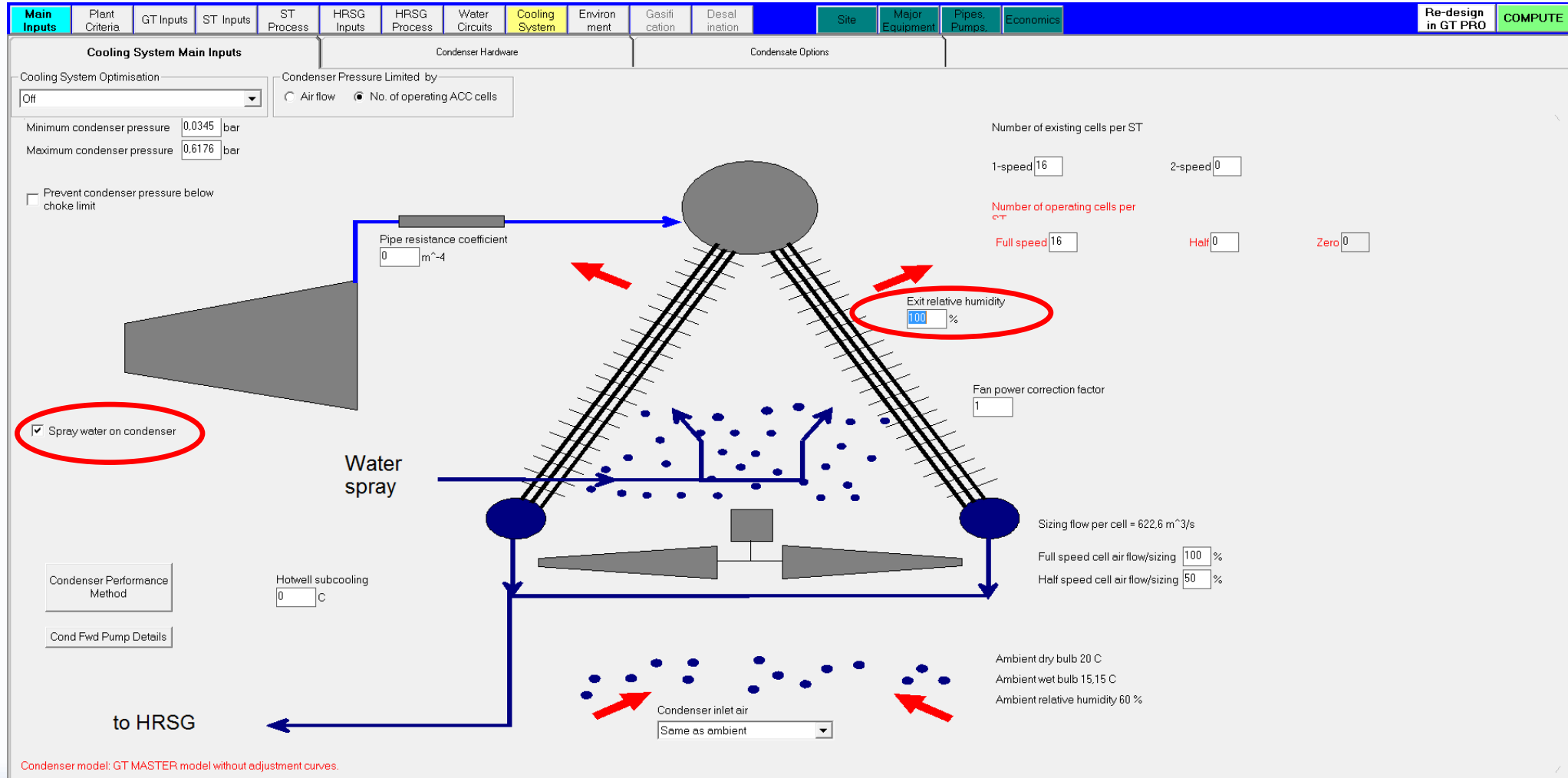

Spray Water to ACC to increase output at peak conditions

No Spray

Gross Power	401385 kW
Net Power	390445 kW
Aux. & Losses	10940 kW
LHV Gross Heat Rate	6355 kJ/kWh
LHV Net Heat Rate	6533 kJ/kWh
LHV Gross Electric Eff.	56,64 %
LHV Net Electric Eff.	55,1 %

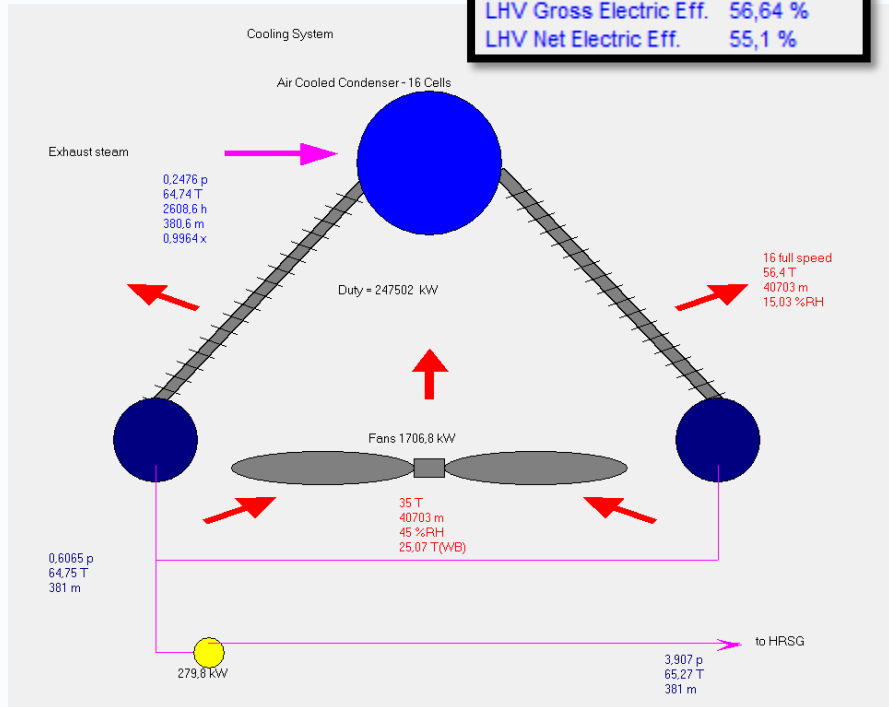

Spray

Gross Power	414946 kW
Net Power	404036 kW
Aux. & Losses	10910 kW
LHV Gross Heat Rate	6148 kJ/kWh
LHV Net Heat Rate	6314 kJ/kWh
LHV Gross Electric Eff.	58,56 %
LHV Net Electric Eff.	57,02 %

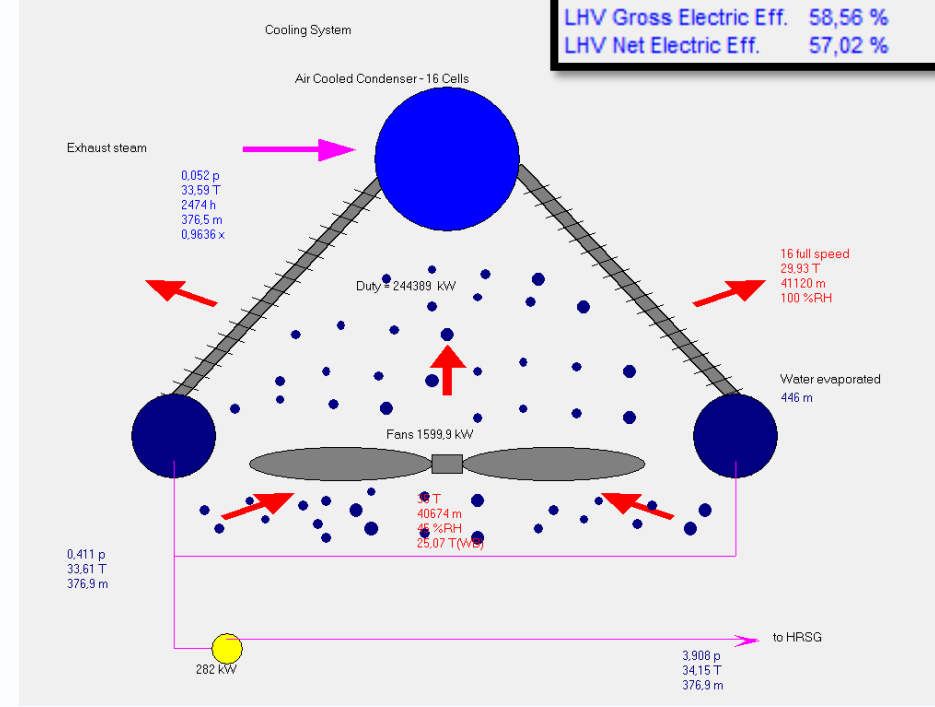

Spray Water to ACC to increase output at peak conditions

Ambient temperature

Additional Power (net)

Water consumption (100% RH at air exit)

Water consumption per additional Power

C	20	25	30	35	40
MW	2,3	5,3	9,1	13,6	18,4
t/h	425,2	454,3	480,7	502,9	521,9
(t/h) / MW	183,0	86,1	52,7	37,1	28,3

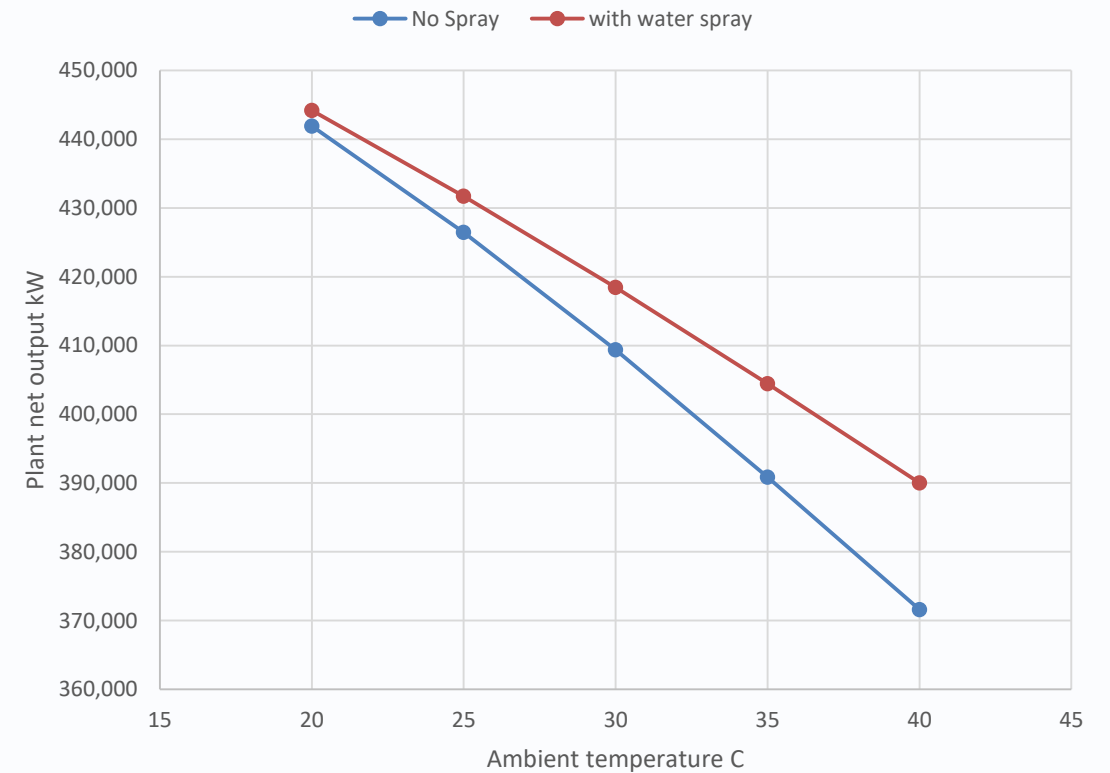
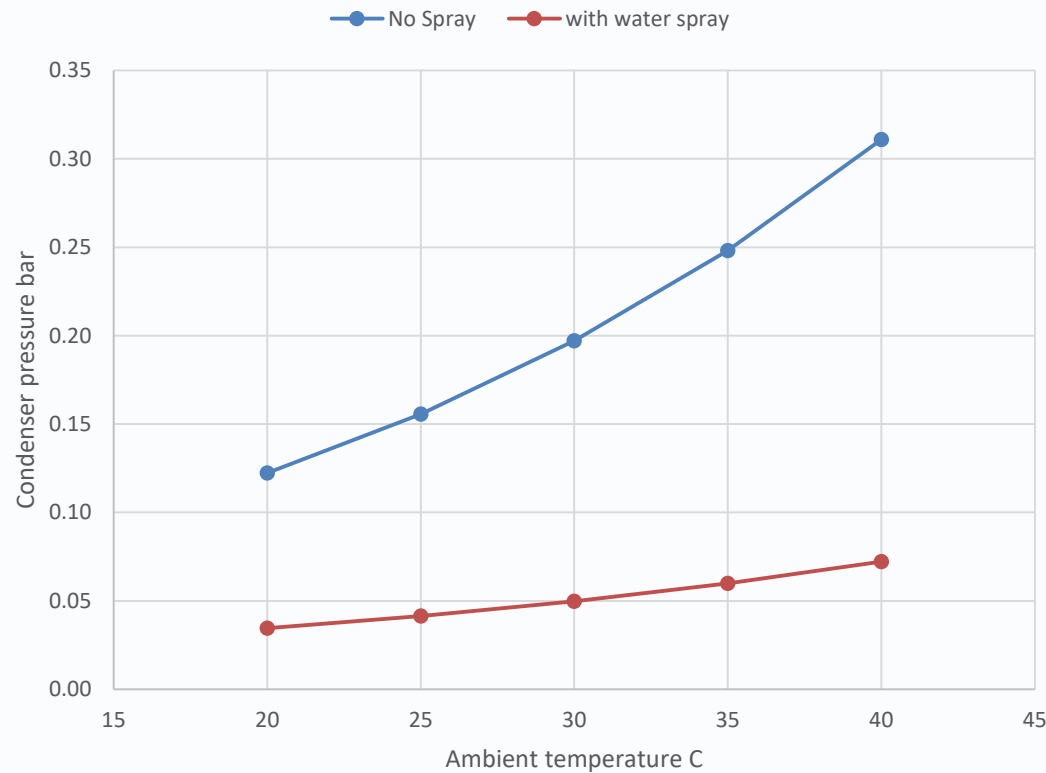

CT n. of cells optimization to maximize Net Power using Searcher

Example 4: Thermoflex, GT SGT5-4000F, 3PRH, WCC+WCT, 2 CWPumps. CT Optimization @ 2 C

Searcher

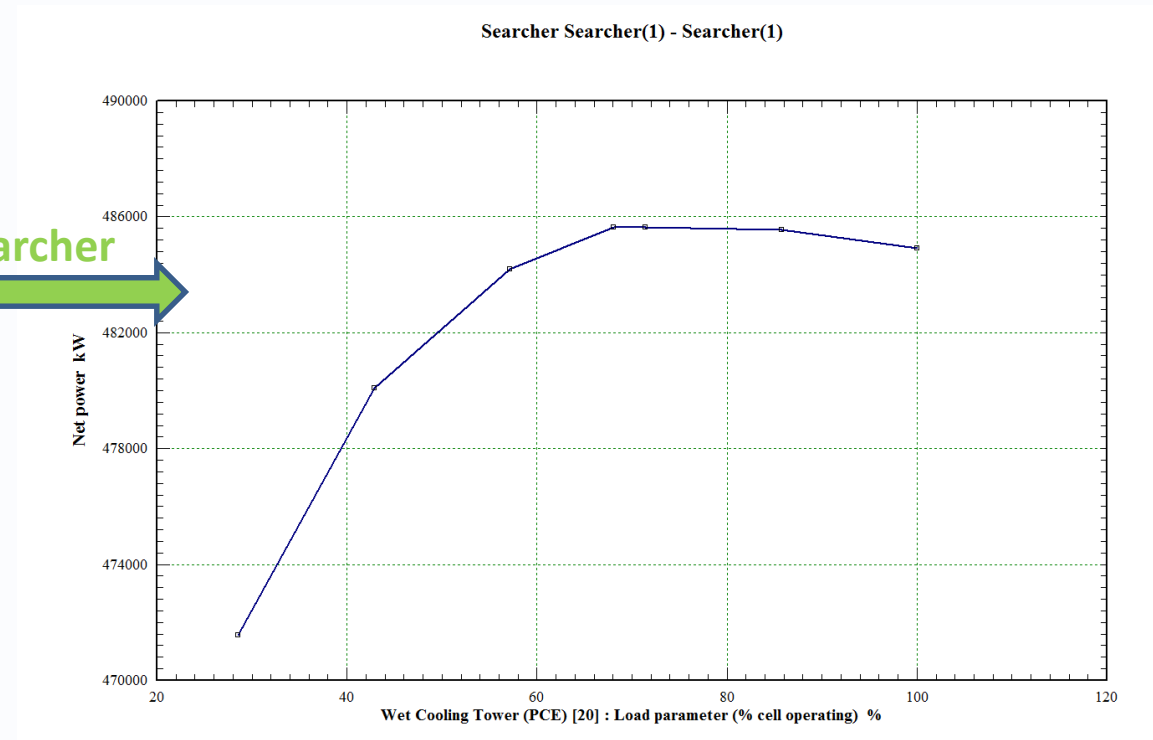

CT n. of cells optimization to maximize Net Power using Searcher

CT n. of cells Optimization with 1 or 2 CW pumps running (ELink)

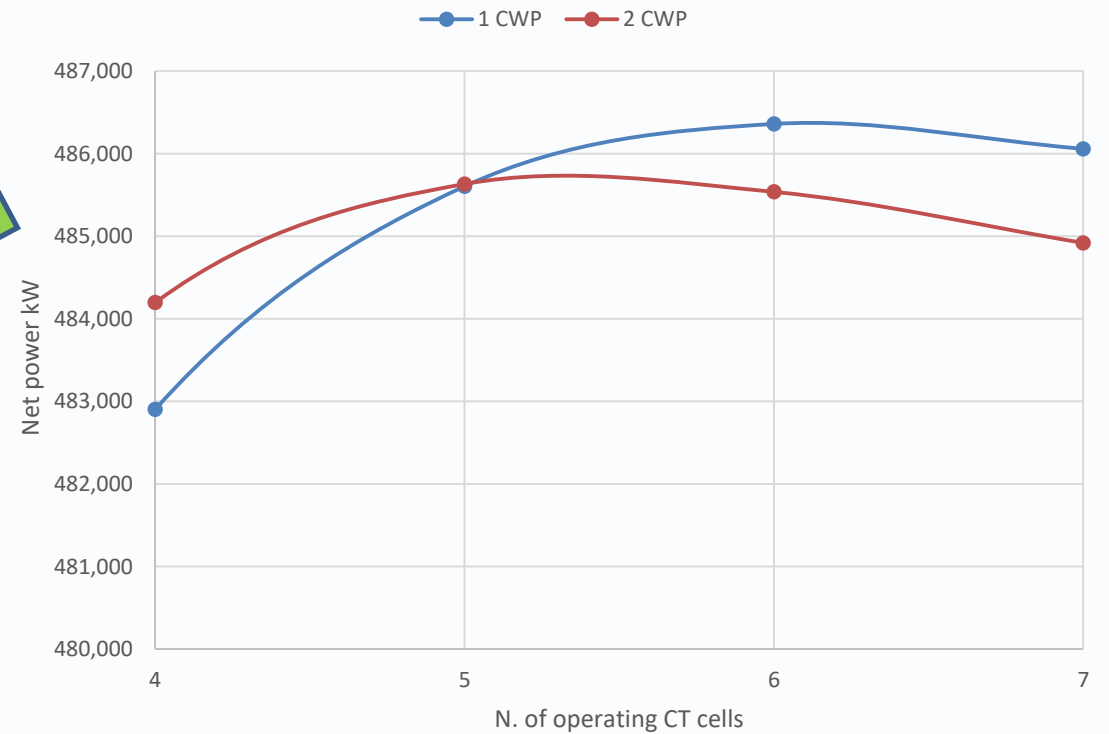
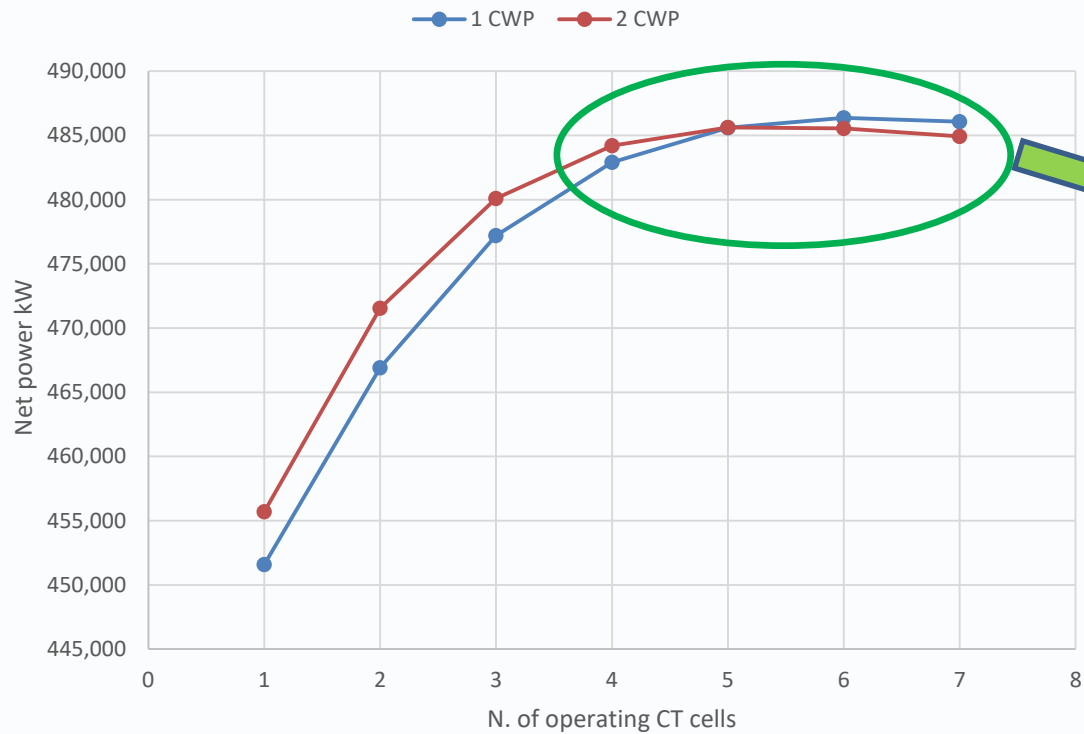

Hybrid Condenser in TFX, link to GTP/GTM

Example 5: Thermoflex & GTPM, GT SGT5-4000F, 3PRH, Hybrid Condenser, 50-50 at 20 C

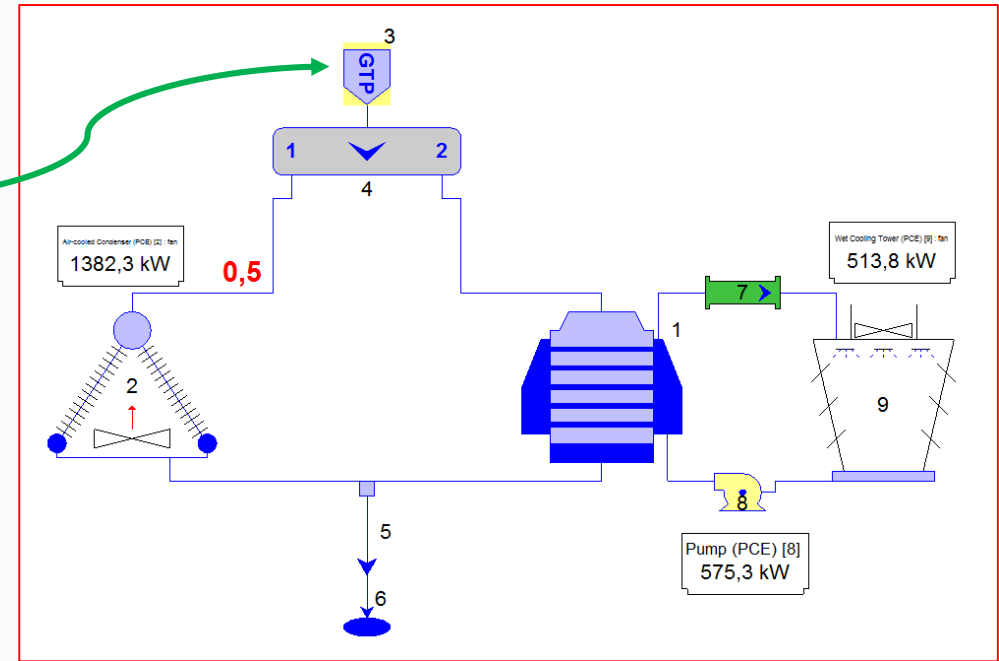
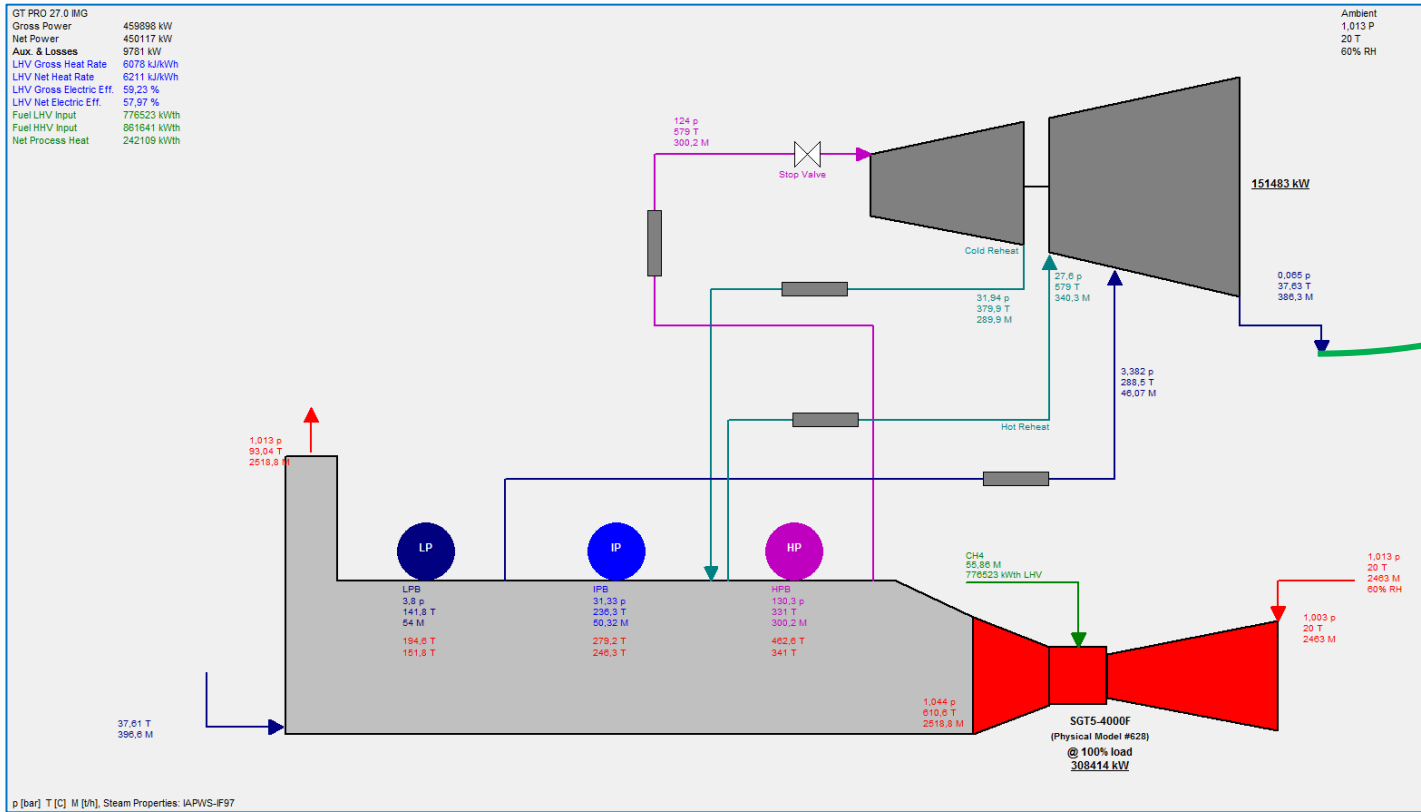

Hybrid Condenser in TFX, link to GTP/GTM

Design → TFX (ED) & GTP, T=20 C, 50%-50% Split, sizing the condensers

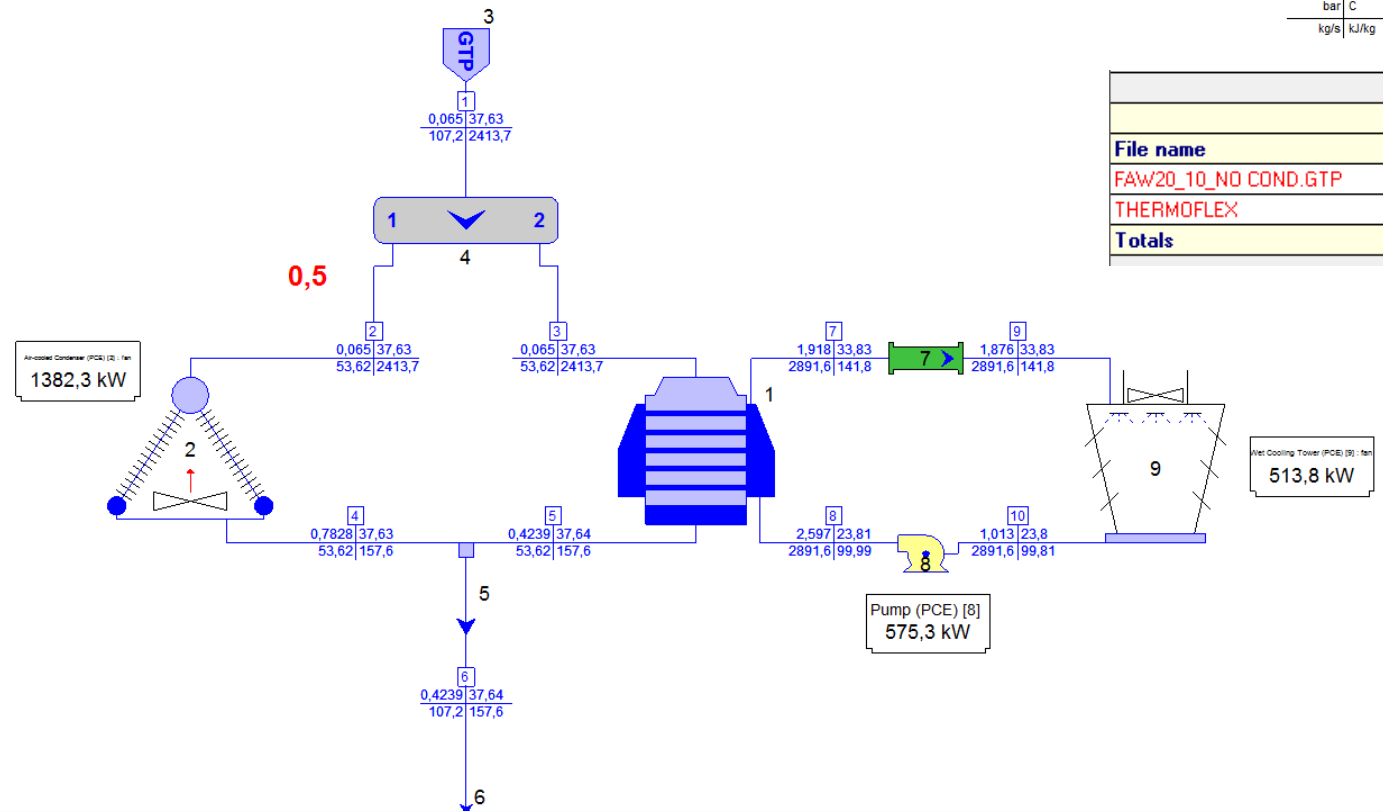

bar | C
kg/s | kJ/kg

Results from both programs combined in TFX

Summary of TFX & Linked Files			
	Gross power	Net power	Net HR
File name	[kW]	[kW]	[kJ/kWh]
FAW20_10_NO COND.GTP	459737	449961	6210
THERMOFLEX		-2471,3	
Totals	459737	447490	6244

Cost Breakdown	Unit Cost	Cost Adj. Factor	Ref. Cost	Est. Cost	
Sum of Costs for Equipment and PEACE Components & Linked Files			287.904.500	311.971.900	USD
FAW20_10_NO COND.GTP			265.667.900	287.810.600	USD
Pump (PCE)			375.389	397.558	USD
Pump (PCE) [8]	375.389	1			
Water-cooled Condenser (PCE)			2.176.807	2.357.284	USD
Water-cooled Condenser (PCE) [1]	2.176.807	1			
Wet Cooling Tower (PCE)			1.988.332	2.159.866	USD
Wet Cooling Tower (PCE) [9]	1.988.332	1			
Pipe (PCE)			335.355	366.962	USD
Pipe (PCE) [7]	335.355	1			
Air-cooled Condenser (PCE)			17.360.790	18.879.600	USD
Air-cooled Condenser (PCE) [2]	17.360.790	1			

Hybrid Condenser in TFX, link to GTP/GTM

Simulation: TFX (OD) & GTM

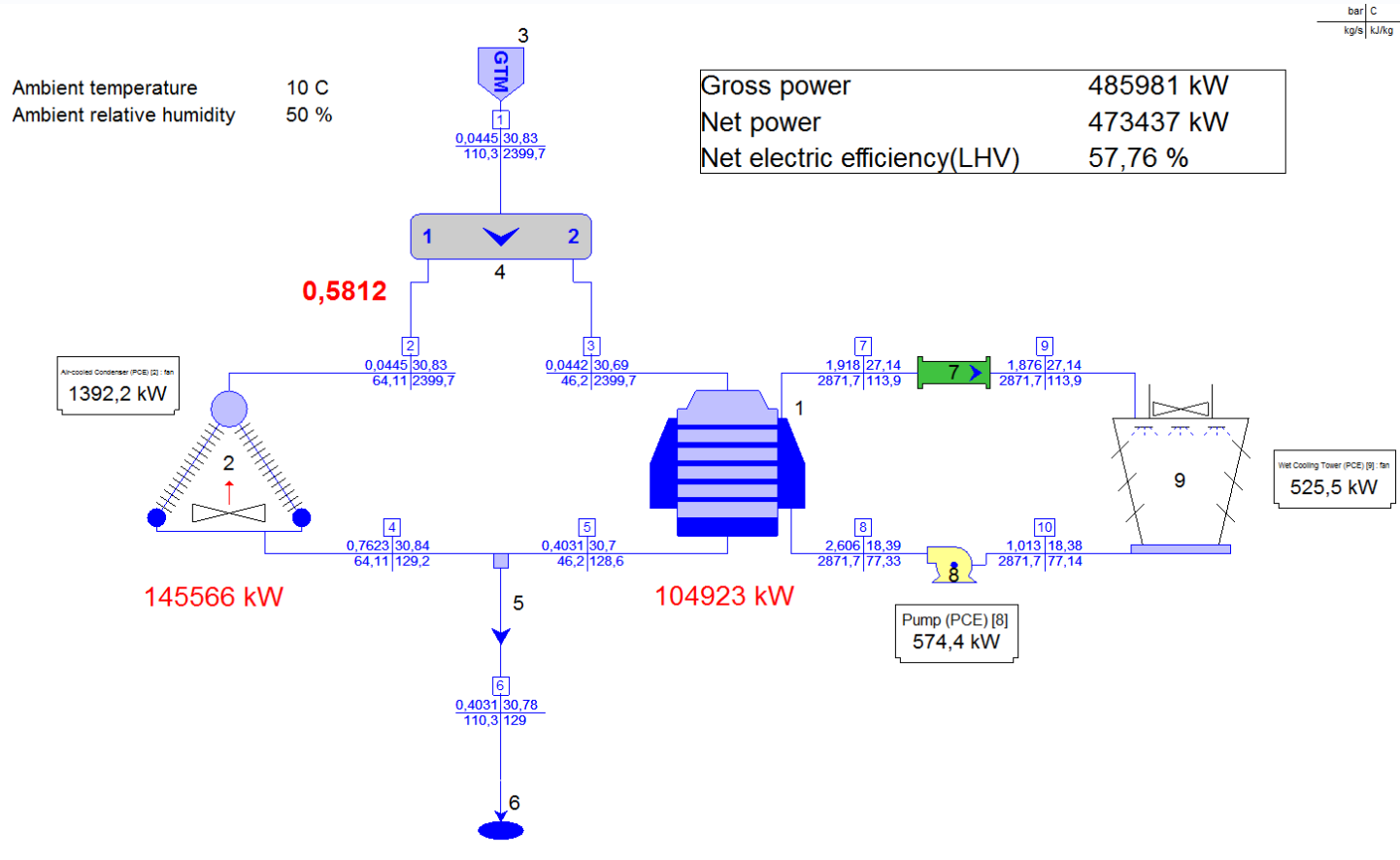

Macros at different Amb T

Parameter	Units	Case 1	Case 2	Case 3	Case 4	Case 5
Ambient temperature	C	7,459852E-06	10	20	30	40
Ambient relative humidity	%	50	50	50	50	50
Ambient temperature	C	7,459852E-06	10	20	30	40
Ambient RH	%	50	50	50	50	50
Gross power	kW	491948	485981	459646	427920	391337
Net power	kW	479326	473437	447400	415990	379768
Net electric efficiency(LHV)	%	57,438	57,7557	57,6409	56,8112	55,3949
Generator, Motor, and Aux Loads: Air-cooled Condenser (PCE) [2] : fan	kW	1401,51	1392,25	1381,31	1370,3	1357,72
Generator, Motor, and Aux Loads: Pump (PCE) [8]	kW	572,952	574,405	575,272	575,725	575,865
Generator, Motor, and Aux Loads: Wet Cooling Tower (PCE) [9] : fan	kW	538,117	525,493	513,943	502,127	489,862
Air-cooled Condenser (PCE) [2] : Condenser pressure	bar	0,0284208	0,0445321	0,0651077	0,094589	0,135892
Air-cooled Condenser (PCE) [2] : Condenser heat rejection	kW	163737	145566	122035	100627	80699,9
Water-cooled Condenser (PCE) [1] : Condenser heat rejection (per unit)	kW	89721,4	104923	120075	137864	155790
Balancing Splitter [4] : Actual flow fraction of 1st outlet		0,645936	0,581191	0,504114	0,421982	0,341276

Q & A Session

- Please forward your questions to the WebEx Chat
- Further questions by email to: info@thermoflow.com

- PP Presentation will be available on the Website / Tutorials
- Video will be available on the Service Center

Thank you!

IGNACIO MARTIN
Málaga – SPAIN
martin@thermoflow.com